



GRUNDOMAT

Soil displacement hammer





Why trenchless ?

- ➔ Trenchless installation reduces damages of valuable surfaces
- ➔ Trenchless installation reduces excavations
- ➔ Trenchless installation reduces expensive disposal of road surface material
- ➔ Trenchless installation reduces the number of transportations of soil material
- ➔ Trenchless installation reduces the need for backfill material
- ➔ Trenchless installation reduces the danger of improperly compacted excavations
- ➔ Trenchless installation reduces noise annoyance
- ➔ Trenchless installation avoids traffic disturbance and annoyance of the residents
- ➔ Trenchless installation reduces the need for ground water lowering
- ➔ Trenchless installation reduces the impact on the environment
- ➔ Trenchless installation reduces the need for lining equipment
- ➔ Trenchless installation reduces construction times





GRUNDOMAT

Principle sketch of the soil displacement technique

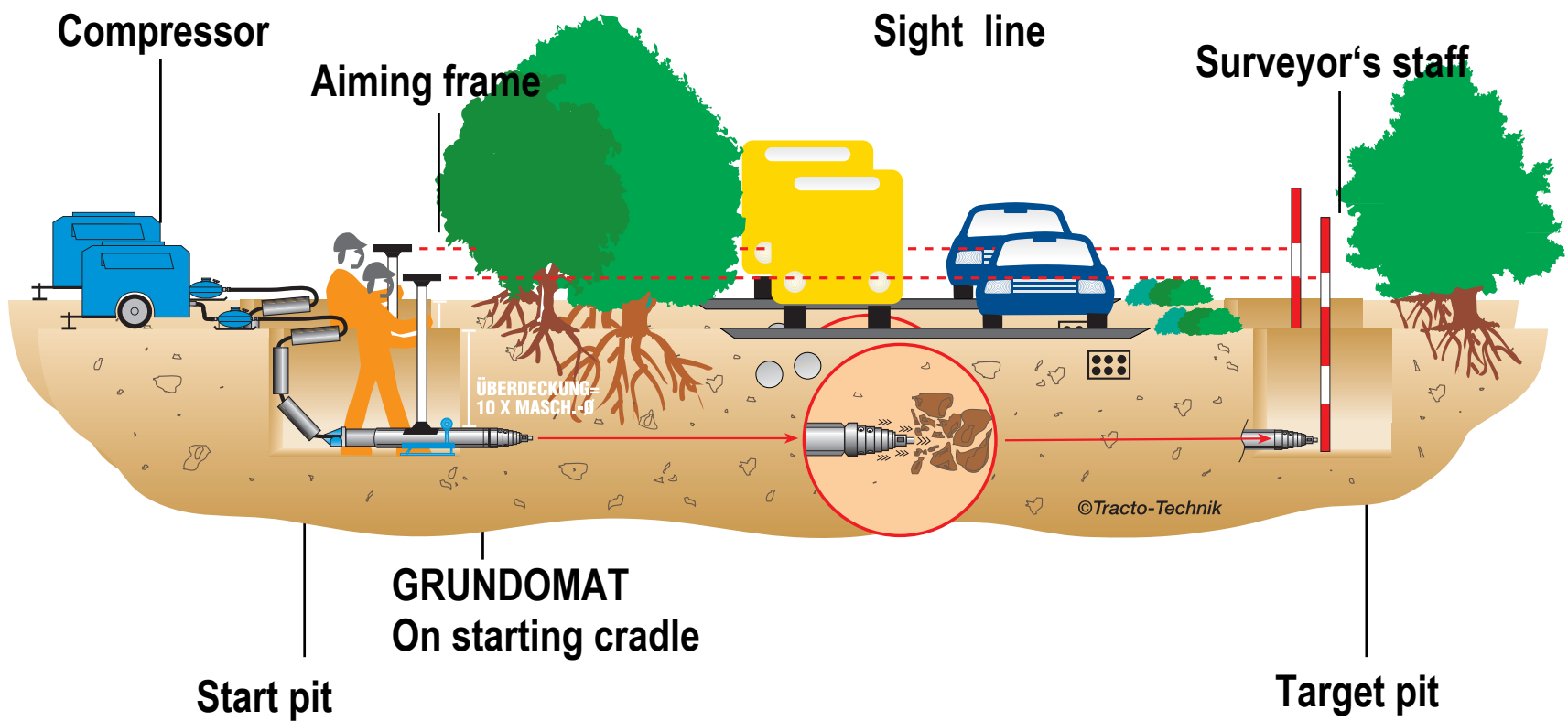



Application of the soil displacement technique

- ➔ House connections (40 % of all applications)**
 - for gas, water, sewage, telecommunication, electricity
 - up to pipe \varnothing : ND 150 (with expander max. ND 200)
- ➔ Undercrossing of streets, railway tracks and paved surfaces**
- ➔ Special applications**
 - Vertikal bores
 - Sheet pile installation
 - Steel pipe installation



Stepped Moveable Head or Slim Fixed Head ? Conv. Impact Moles: One Stroke System

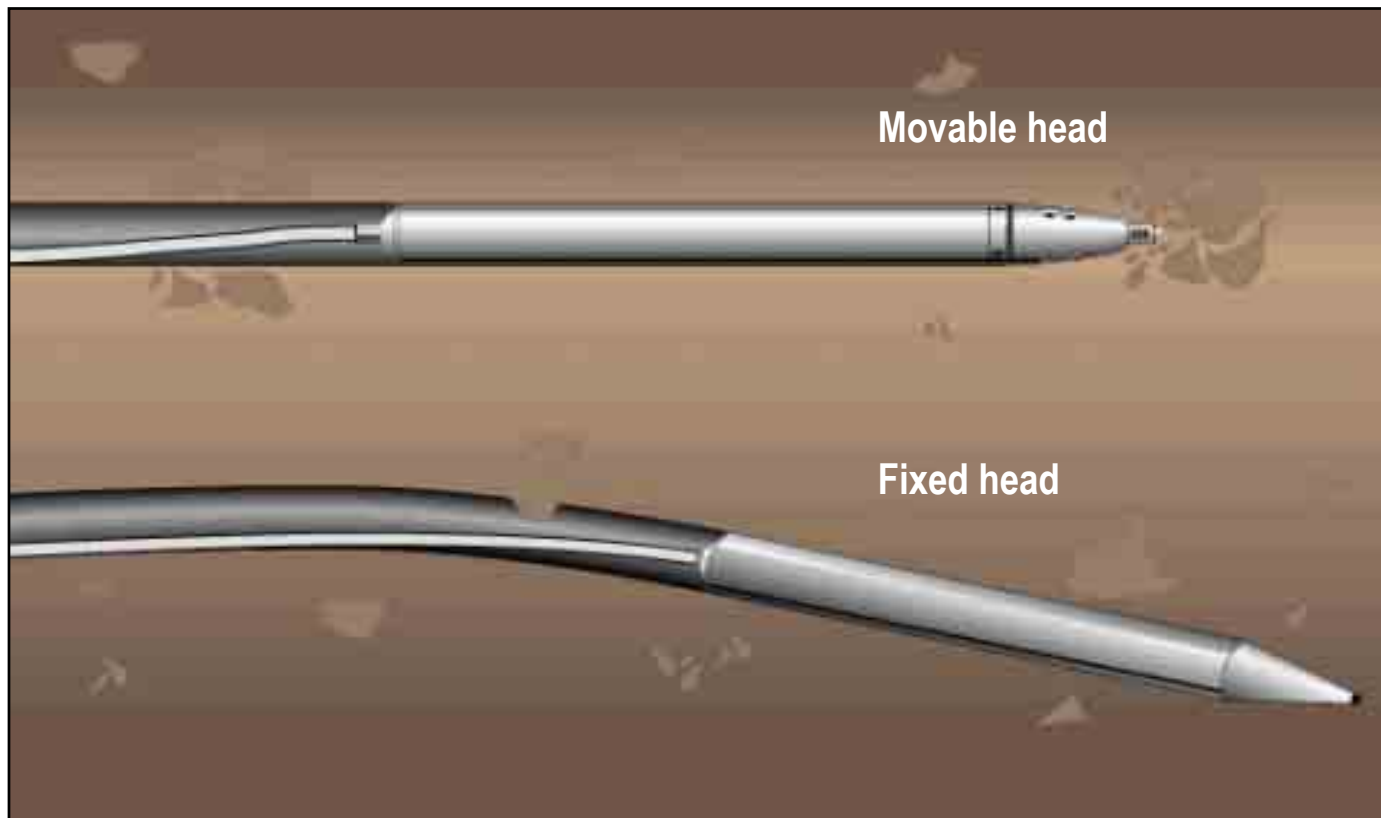

Reciprocating head impact system

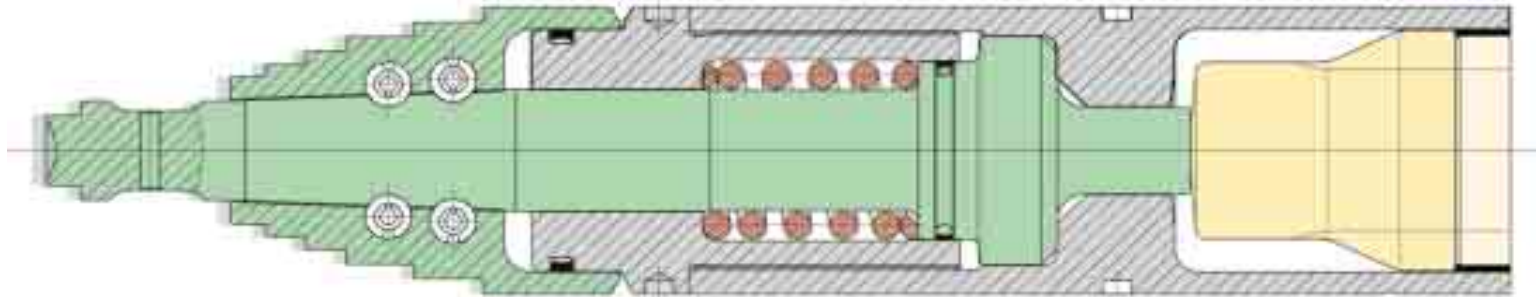

- ➔ **Reciprocating head impact system which automatically adjusts to the front resistance and casing friction**
- ➔ **Proven 2-stroke system, thus high directional stability even when stone inclusions occur and using minimum soil cover**
- ➔ **Higher propulsion speed due to the new reciprocating head impact system**
- ➔ **lower weight with higher piston weight for more efficiency**
- ➔ **Multicuttercones of all GRUNDOMAT sizes fitted with lock pins**
- ➔ **Chisel and multicuttercone specially hardened**





Reciprocating head GRUNDOMAT 130P

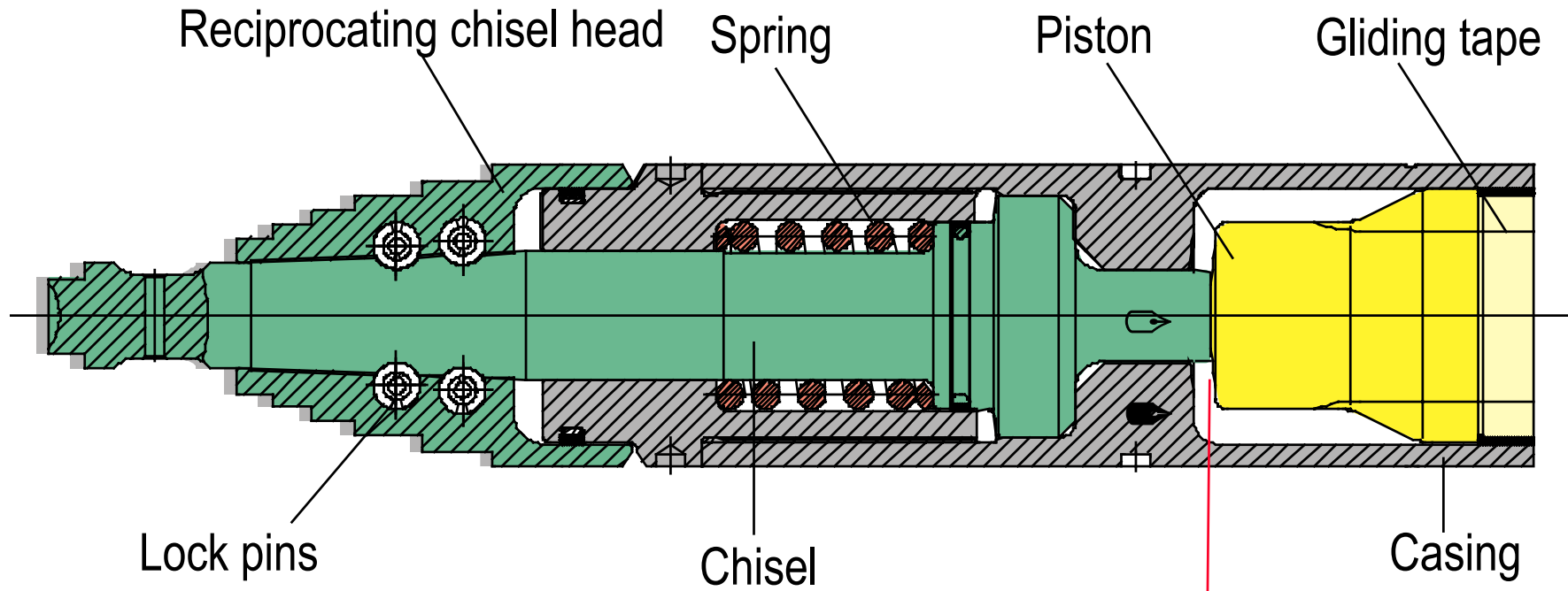

The Piston strikes onto

- ➔ the chisel
- ➔ the casing



The reciprocating Grundomat- chisel head (Two-stroke action)

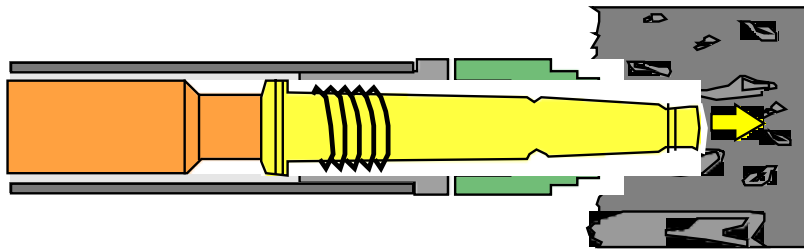

In the 1st step, the piston strikes onto the chisel head

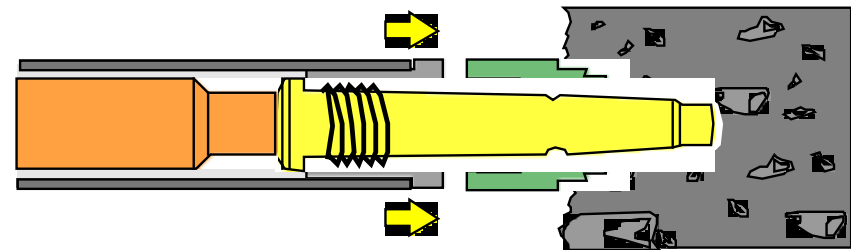

In a 2nd step the piston strikes onto the casing

Fixed head

Piston and casing are moved forward at the same time

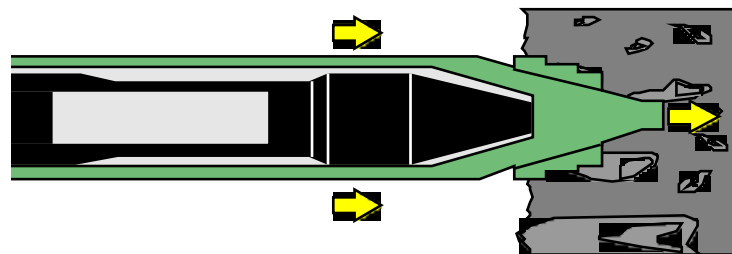

Disadvantages:

- reduced impact energy
- less energy available for overcoming the case friction





GRUNDOMAT Set-up

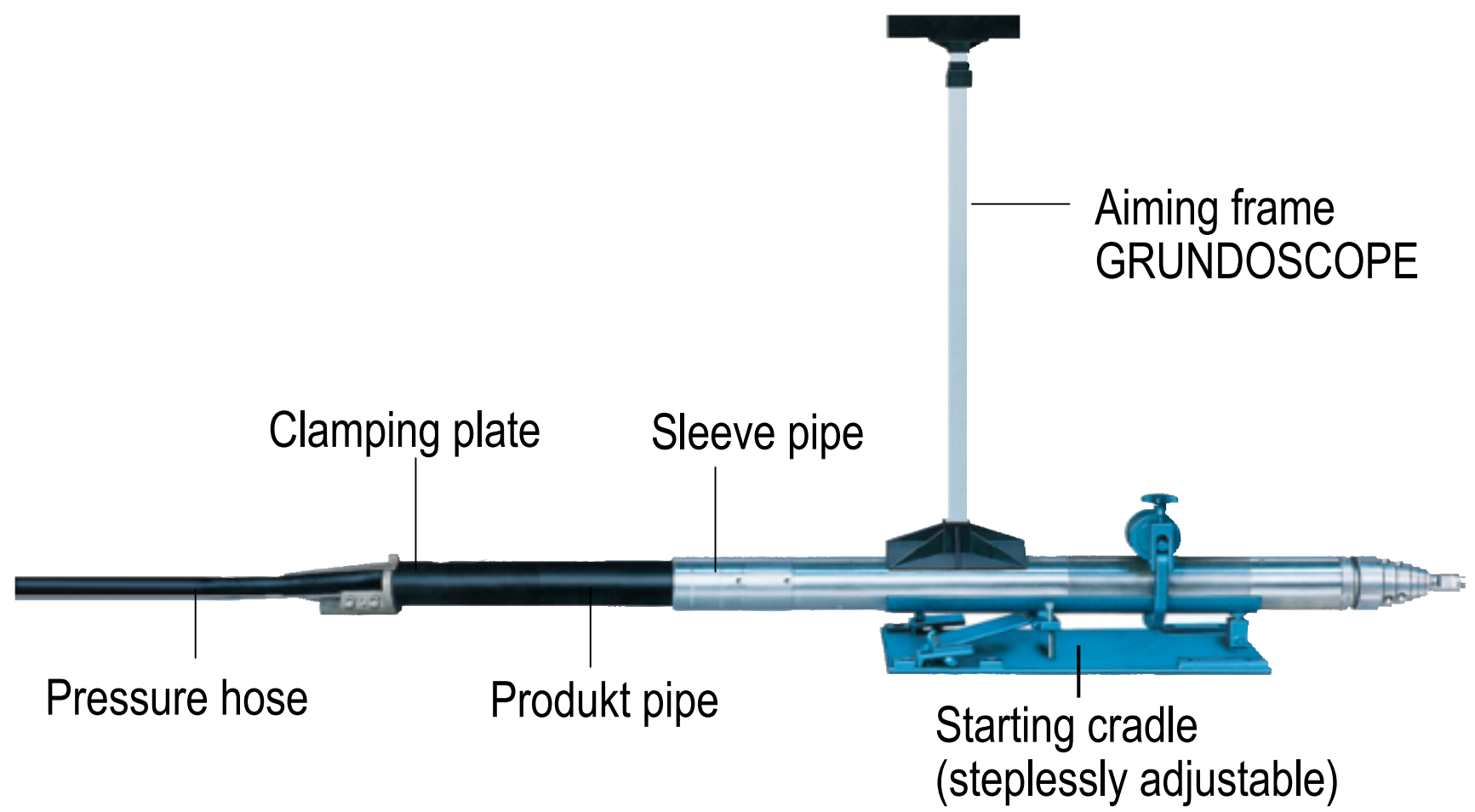



Accessories for Pulling PVC Pipes simultaneously

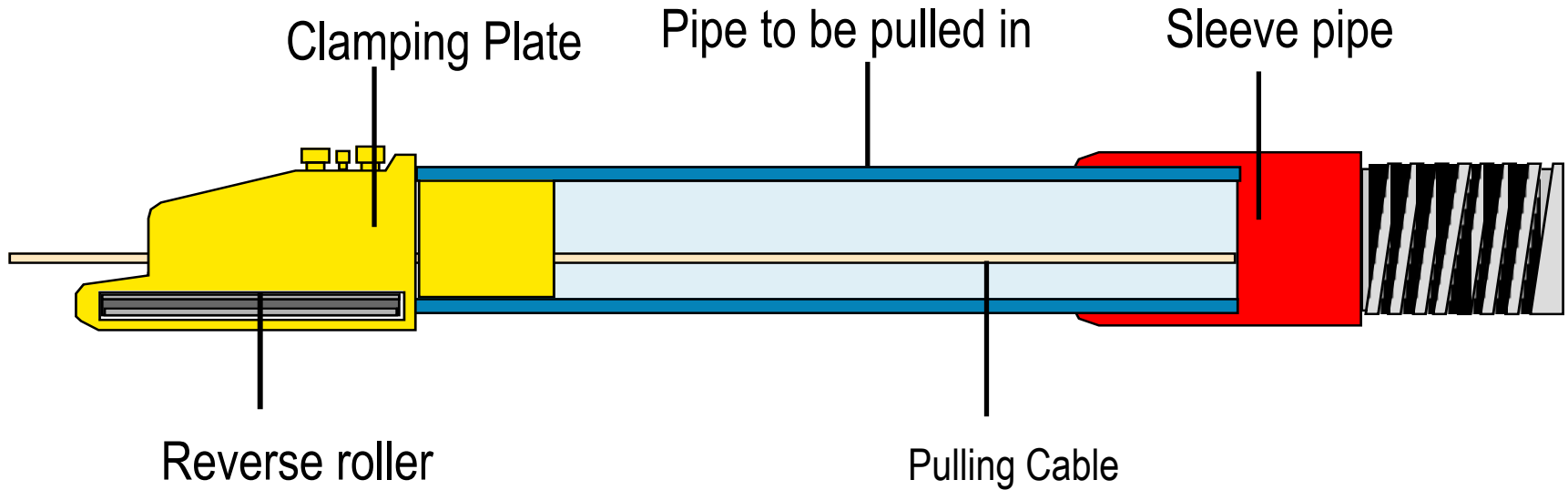

Not every PVC Pipe (joint) can be used !

Not useable

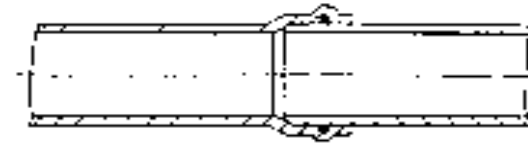

Under certain circumstances useable

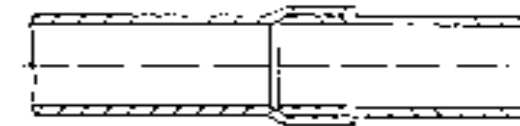

Connection Sleeves

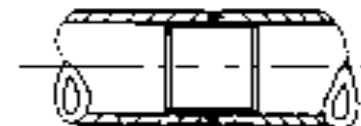

Ideal Pipe





Accessories for Pulling PE pipes simultaneously

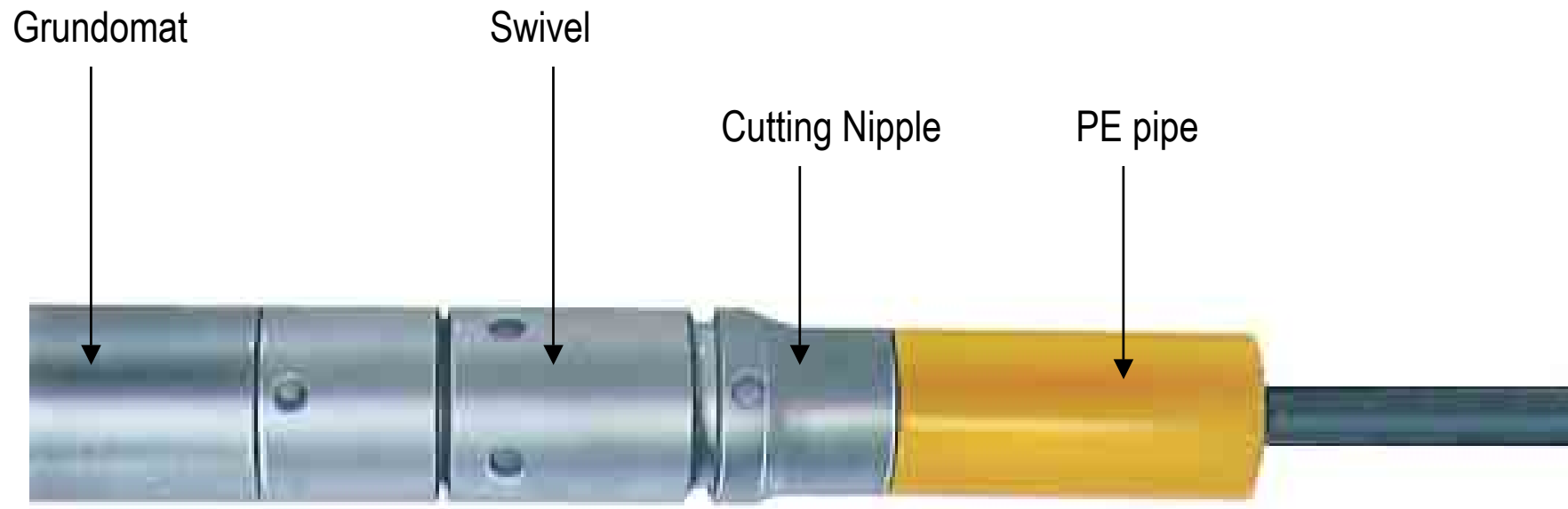



Accessories for Pulling PE Pipes subsequently

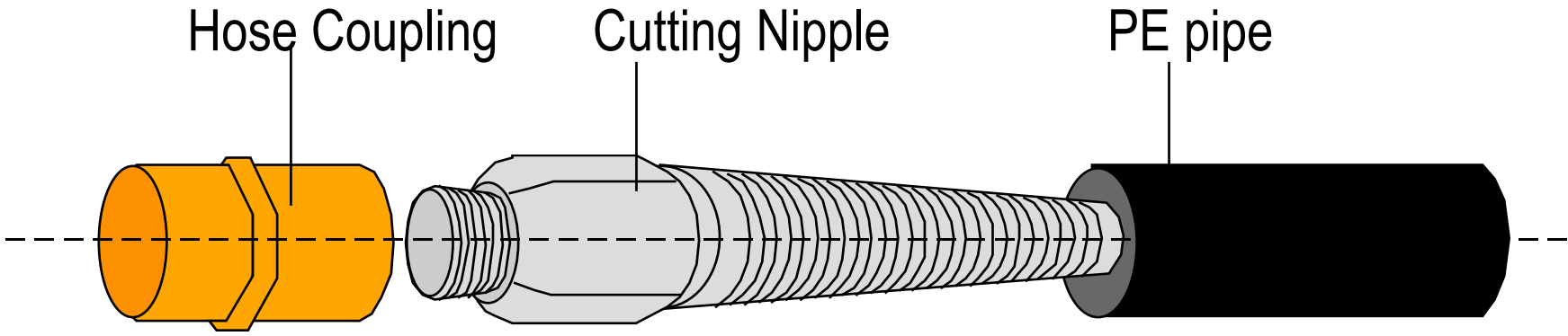

Accessories for Alignment: Starting Cradle

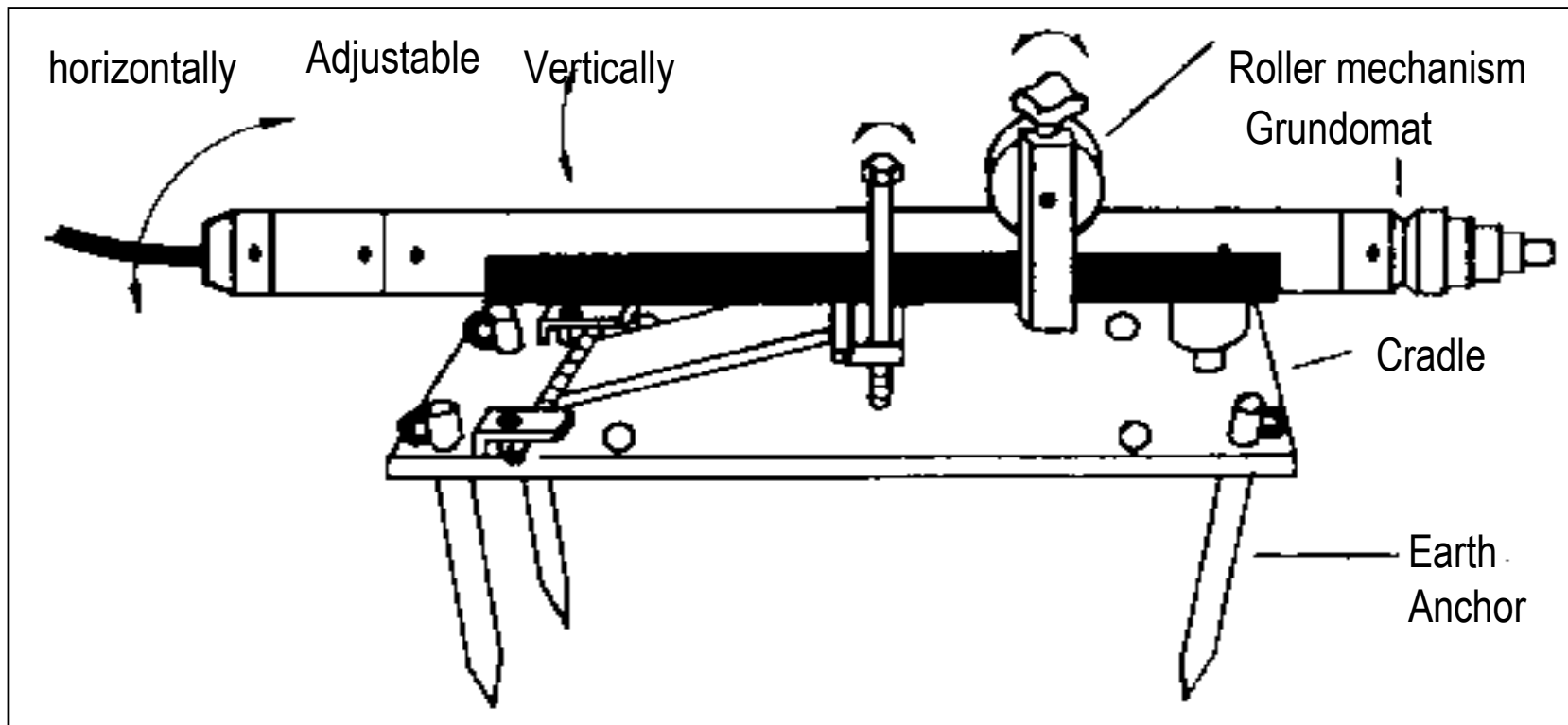

Servo Control Stud for GRUNDOMAT 130 to 180



- ➔ Change of direction by means of axial movement of a control stud bushing
- ➔ easy and service friendly construction
- ➔ Lubricator and control unit in one compact box between GRUNDOMAT and compressor





Servo Control Stud for GRUNDOMAT 130 to 180

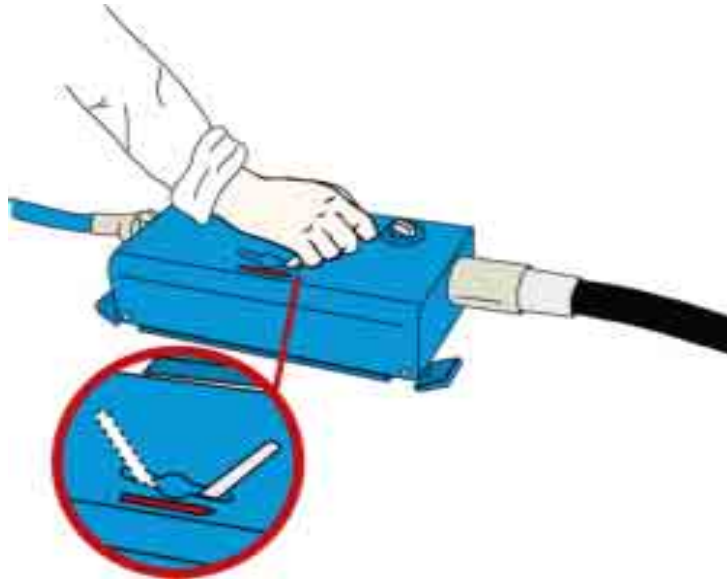

- ➔ easy, power and time saving operation of the TRACTO Servo control stud by means of a lever
- ➔ no restarting problems, thus no „kinking“ of the air hose required





Servo Control Stud for GRUNDOMAT 130 to 180



- ➔ reinforced compressed air hoses
- ➔ control hose is safely located inside the air hose
- ➔ Connection of the air hoses by means of a coupling with swivel
- ➔ on-site quick whip hose change facility without the need of detaching the end cone or the pull sleeve



GRUNDOMAT 130 P

Air driven soil displacement hammer





Thank you for your attention!

